

Varenummer: 0118034  
 Beskrivelse: Seeger låsering H 18

## Mål

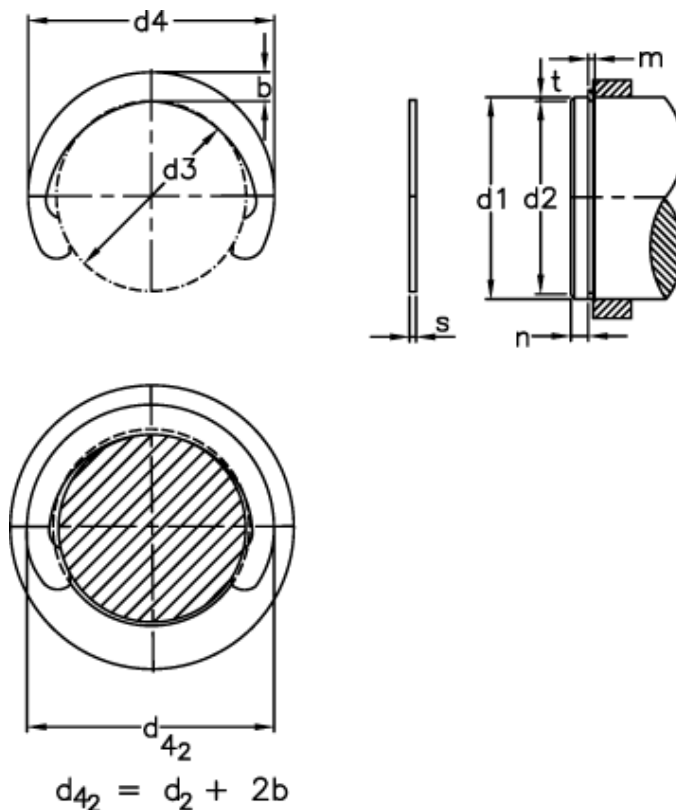

b	= 2.30	FRg kN	= 2.8	t	= 0.85
Betegnelse	= H 18,0	FR kN	= 8.50	tol	= -0.11
d1	= 18	g	= 1.20	tol	= 0.18
d2	= 16.3	Griber	= GRH 18	tol	= -0.06
d3	= 15.80	m min	= 1.30	vægt kg/1000	= 0.72
d4	= 20.40	n abl x 1000	= 21		
d4 2	= 20.9	Nominel træk	= 2.6		
FN kN	= 3.70	s	= 1.20		